

New!



Features

- Designed to meet MIL-STD-810 shock and vibration
- Designed to meet EMC/EMI per MIL-STD-461 EMC
- 4U 19-inch rugged rackmount PC server chassis, 22" deep
- Windows® 7 Professional workstation with high-performance Intel® Core™ i7 processor
- 500 MHz 12-bit A/Ds or 400 MHz 14-bit A/Ds
- 800 MHz 16-bit D/As
- Real-time aggregate recording rates of up to 5.0 GB/sec
- 200 MHz max. record and playback signal bandwidths
- Capable of record/playback of IF frequencies to 700 MHz
- Up to four front-panel removable QuickPac SSD drive canisters with eight drives each
- Up to 30 terabytes of storage to NTFS RAID disk array
- SystemFlow® GUI with signal viewer analysis tool
- C-callable API for integration of recorder into application
- File headers include time stamping and recording parameters
- Optional GPS time and position stamping

General Information

The Talon® RTX 2767 is a turnkey, multi-band record and playback system that is built to operate under harsh conditions. Designed to withstand high vibration and operating temperatures, the RTX 2767 is intended for military, airborne and UAV applications requiring a rugged system. With scalable A/Ds, D/As and SSD (Solid-State Drive) storage, the RTX 2767 can be configured to stream data to and from disk at rates as high as 5.0 GB/sec

The RTX 2767 uses Pentek's high-powered Virtex-6-based Cobalt® boards that provide flexibility in channel count, with optional digital downconversion capabilities. Optional 16-bit, 800 MHz D/A converters with digital upconversion allow real-time reproduction of recorded signals.

A/D sampling rates, DDC decimations and bandwidths, D/A sampling rates and DUC interpolations are among the GUI-selectable system parameters, providing a fully-programmable system capable of recording and reproducing a wide range of signals.

Optional GPS time and position stamping allows the user to record this critical signal information.

SystemFlow Software

The RTX 2767 includes the SystemFlow Recording Software. SystemFlow features a Windows-based GUI (Graphical User Interface) that provides a simple means to configure and control the recorder.

Custom configurations can be stored as profiles and later loaded when needed,

allowing the user to select preconfigured settings with a single click.

SystemFlow also includes signal viewing and analysis tools, that allow the user to monitor the signal prior to, during, and after a recording session. These tools include a virtual oscilloscope and a virtual spectrum analyzer.

Built on a Windows 7 Professional workstation, the RTX 2767 allows the user to install post processing and analysis tools to operate on the recorded data. The RTX 2767 records data to the native NTFS file system, providing immediate access to the recorded data.

Data can be off-loaded via two rear-access gigabit Ethernet ports, two USB 3.0 ports or up to four USB 2.0 ports.

Rugged Mil-Spec Chassis

The Talon RTX 2767 uses a shock- and vibration-isolated inner chassis and solid-state drives to assure reliability under harsh conditions. The chassis uses an in-line EMI filter along with rear-panel MIL-style connectors to meet MIL-STD-461 emissions specifications.

Up to four front-panel removable QuickPac drive canisters are provided, each containing up to eight SSDs. Each drive canister can hold up to 7.6 TB of data storage and allows for quick and easy removal of mission-critical data.

Forced-air cooling draws air from the front of the chassis and pushes it out the back via exhaust fans. A hinged front door with a serviceable air filter provides protection against dust and sand. ➤

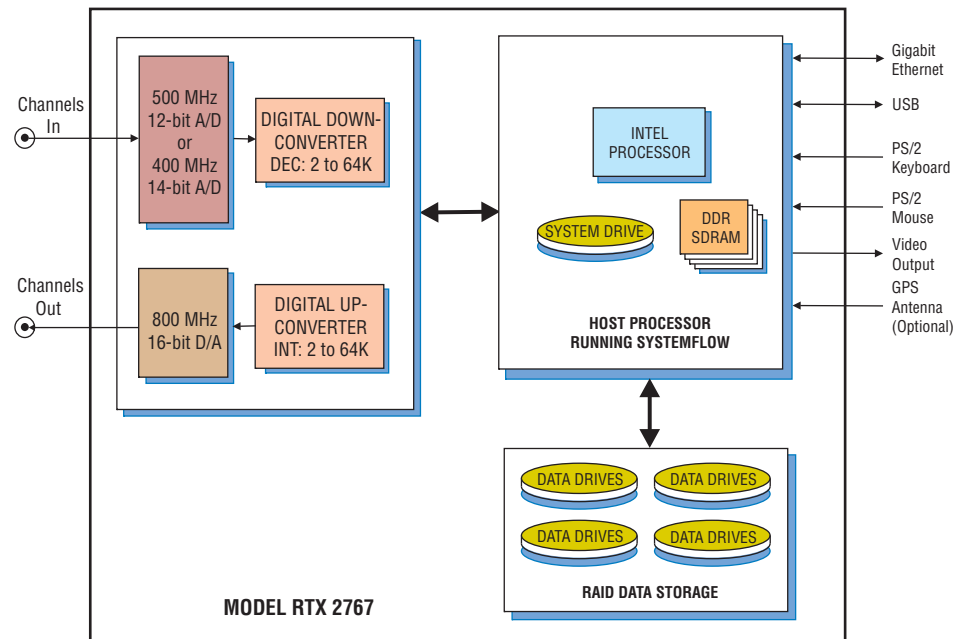

► SystemFlow Graphical User Interface

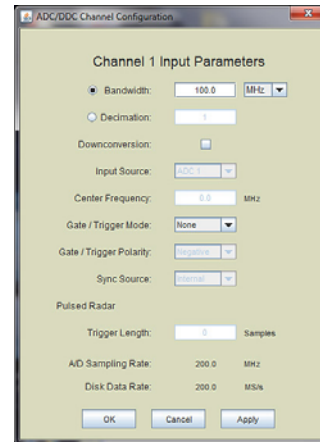
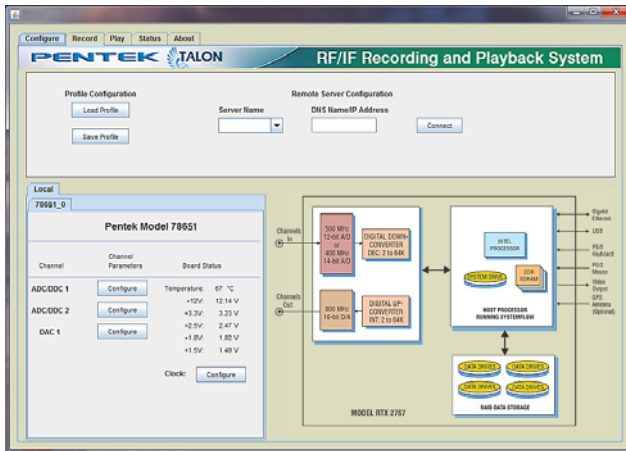

SystemFlow Recorder Interface

The RTX 2767 GUI provides the user with a control interface for the recording system. It includes Configuration, Record, Playback and Status screens, each with intuitive controls and indicators. The user can easily move between screens to set configuration parameters, control and monitor a recording, play back a recorded signal and monitor board temperature and voltage levels. The signal viewer, integrated into the recording GUI, allows the user to monitor real-time signals or signals recorded on disk.

SystemFlow Hardware Configuration Interface

The RTX 2767 Configure screens provide a simple and intuitive means for setting up the system parameters. The DDC configuration screen shown here, allows user entries for input source, center frequency, decimation, as well as gate and trigger information. All parameters contain limit-checking and integrated help to provide an easier-to-use out-of-the-box experience.

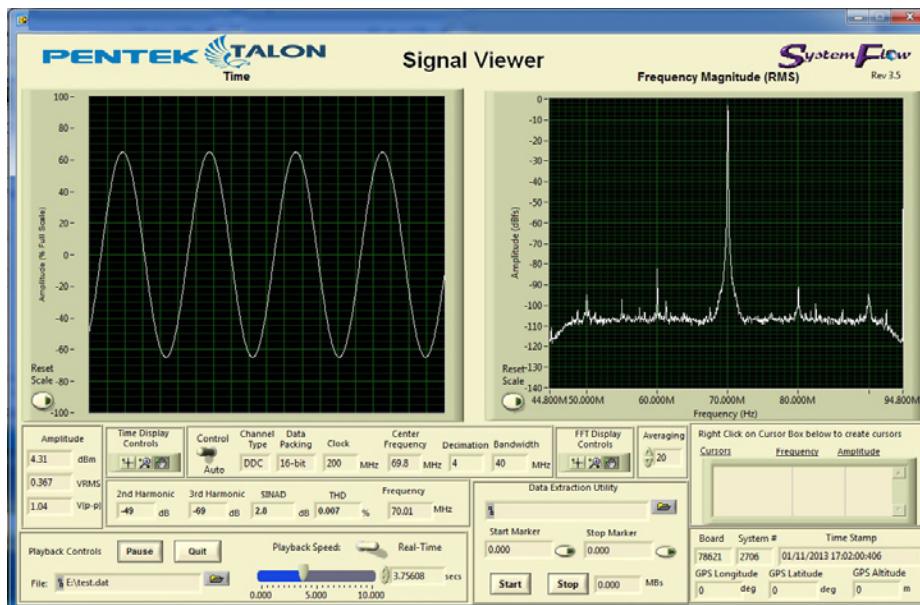

SystemFlow Signal Viewer

The SystemFlow Signal Viewer includes a virtual oscilloscope and spectrum analyzer for signal monitoring in both the time and frequency domains. It is extremely useful for previewing live inputs prior to recording, and for monitoring signals as they are being recorded to help ensure successful recording sessions. The viewer can also be used to inspect and analyze the recorded files after the recording is complete.

Advanced signal analysis capabilities include automatic calculators for signal amplitude and frequency, second and third harmonic components, THD (total harmonic distortion) and SINAD (signal to noise and distortion). With time and frequency zoom, panning modes and dual, annotated cursors to mark and measure points of interest, the SystemFlow Signal Viewer can often eliminate the need for a separate oscilloscope or spectrum analyzer in the field. ►

► Specifications

PC Workstation (standard configuration)

Operating System: Windows 7 Professional

Processor: Intel Core i7 processor

Clock Speed: 3.0 GHz or higher

SDRAM: 8 GB

Data Storage

Style: Up to four front-panel removable QuickPac drive canisters; up to eight SSDs contained in each canister

Location: Front panel

Capacity: Up to 30 TB

Number of Drives: Up to 32 total

Supported RAID Levels: 0, 1, 5 and 6

Analog Recording Inputs

Analog Signal Inputs

Connector Type: Rear-panel female SMA connectors

Input Type: Transformer-coupled

Full Scale Input: +5 dBm into 50 ohms

3 dB Passband: 300 kHz to 700 MHz

A/D Converters

Type: Texas Instruments ADS5463 or ADS5474 (Option -014)

Sample Rate (f_s): 20 MHz to 500 MHz or 20 MHz to 400 MHz (Option -014)

Resolution: 12 bits or 14 bits (Option -014)

A/D Record Bandwidth: $f_s/2 =$ Nyquist bandwidth

Anti-Aliasing Filters: External, user-supplied

Digital Downconverter

Type: Virtex-6 FPGA, Pentek DDC IP Core

Decimation(D): 2 to 65,536

IF Center Frequency Tuning: DC to f_s , 32 bits

DDC Usable Bandwidth: $0.4*f_s/D$

Sample and Reference Clocks

External Sample Clock: Sine wave, 0 to +10 dBm, AC-coupled, 50 ohms 20 to 500 MHz, common to all A/Ds

VCXO Sample Clock: Programmable, 20 to 500 MHz, phase-locked to 10MHz reference, common to all A/Ds

Reference Clock: Sine wave, 0 to +10 dBm, A-C coupled, 50 ohms, 10 MHz, used for phase-locking the VCXO

Connector Type: Rear panel female SMA connector for external sample or reference clock input

External Trigger

Number: One common trigger for all input channels ►

► **Input Level:** LVTTTL with selectable rising or falling edge

Connector Type: Rear panel female SMA connector

Analog Playback Output Channels

Analog Signal Outputs

Output Type: Rear-panel female SSMC connectors

Full Scale Output: +4 dBm into 50 ohms

3 dB Passband: 300 kHz to 700 MHz

D/A Converters

Type: Texas Instruments DAC5688 or DAC3484, depending on option set

Output Sampling Rate: Up to 800 MHz or 1.25 GHz

Resolution: 16 bits

Input Sample Data Rate: 250 or 312.5 MHz

Output IF: Up to 400 MHz or 625 MHz

Digital Upconverters

Type: Virtex-6 FPGA, Pentek interpolation IP core

Overall Interpolation: 2 to 65,536 including D/A

Sample and Reference Clocks

External Sample Clock: Sine wave, 0 to +10 dBm, AC-coupled, 50 ohms 800 MHz or 1.25 GHz, common to all D/As

VCXO Sample Clock: Programmable, up to 1.25 GHz, phase-locked to 10MHz reference, common to all D/As

Reference Clock: Sine wave, 0 to +10 dBm, A-C coupled, 50 ohms, 10 MHz, used for phase-locking the VCXO

Connector Type: Rear panel female SMA connector for external sample or reference clock input

External Trigger

Number: One common trigger for all output channels

Input Level: LVTTTL with selectable rising or falling edge

Connector Type: Rear panel female SMA connector

Physical and Environmental

Dimensions: 19" W x 22" D x 7" H

Weight: 50 lb, approx.

Operating Temp: -20° to +50° C

Storage Temp: -40° to +85° C

Relative Humidity: 10% to 95%, non-condensing

Operating Shock: Designed to MIL-STD 810F, method 514.5, procedures I and VI

Operating Vibration: Designed to MIL-STD 810F, method 514.5, procedure I

EMI/EMC: Designed to MIL-STD 461E, CE101, CE102, CS101, CS113, RE101, RE102, RS101, RS103

Input Power: 85 to 264 VAC, 47– 400 Hz, 600 W max.

Model RTX 2767 Order Information and Options

Recording Options

Option -201	1-Channel
Option -202	2-Channel
Option -204	4-Channel

Playback Options

Option -221	1-Channel
Option -222	2-Channel

Storage Options

Option -242	3.8 TB
Option -244	7.6 TB ►

► Storage Options

Option -245	11.5 TB
Option -246	15.3 TB
Option -247	23.0 TB
Option -249	30.7 TB

General Options

Option -014	400 MHz, 14-bit A/Ds
Option -261	GPS time & position stamping
Option -264	IRIG-B time stamping
Option -680	28 VDC power supply

Contact Pentek for compatible Option combinations

Storage and Channel-count Options may change, contact Pentek for the latest information

Specifications are subject to change without notice



Figure 1. Rackmount RTX chassis is designed to meet or exceed Mil Specs.



Figure 2. Chassis View showing one QuickPac canister partially withdrawn.

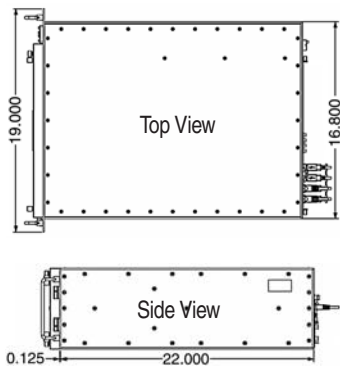

Figure 3. Dimensional drawings of the rackmount enclosure.

Extreme Rackmount Recorders

Pentek's Talon® RTX Rackmount series recorders are designed to provide a combination of high performance and large storage capacity in a military-specified rackmount chassis. Designed for field operation, the RTX Rackmount series provides up to 30 TB of SSD storage with aggregate recording rates up to 5 GB/sec.

Military Specifications

All Talon RTX rackmount recorders are designed to meet military specifications for temperature, altitude, shock, vibration, radiated emissions, conducted emissions, ESD, sand and dust.

The following list contains these military specifications.

- **Vibration:** MIL-STD-810F, method 514.5
- **Shock:** MIL-STD-810F, method 516.5
- **EMI/EMC:** MIL-STD-461E, CE101, CE102, CS101 CS114, RE101, RE102, RS101, RS103
- **ESD:** MIL-STD-1686A
- **Sand & Dust:** MIL-STD-810F, method 510

Chassis Design

All Talon RTX rackmount chassis are specially designed using heavy-duty wrought aluminum extrusions to provide superior torsional strength. Extrusions are partially overlapped for superior EMC. The chassis is 4U in height, with a depth of only 22". A fully-loaded chassis weighs as little as 45 lb.

Rear-panel I/O includes bulk-head mounted SMA connectors, a 4-pin 38999 power connector as well as motherboard I/O. Rear-panels are modular and customizable allowing the end-user to specify the desired connectors.

The Operating System drive can be internally hard-mounted or can be made removable. Additionally an internally-mounted optical DVD writer is optional. All drives, OS, DVD and data drives are protected from dust with EMI filters.



Figure 4. The rear panel includes all analog signal connections and can be customized to suit the application requirements.

QuickPac Canisters

In order to provide field engineers the ability to quickly remove and replace storage drives in the field, Pentek has developed the QuickPac™ canisters for use in the Talon RTX rackmount chassis. These canisters hold eight SSDs, providing up to 7.68 TB of storage capacity in each canister. Up to four QuickPac canisters can be installed in a Talon RTX rackmount chassis, providing a total storage capacity of 30 TB.

Fastened by four thumbscrews, QuickPac canisters can easily be swapped in the field, allowing users to replace those filled with data with new, empty ones with very little down time. QuickPac canisters can be transported to the lab for offload or analysis, using one of Pentek's Talon offload or playback systems.

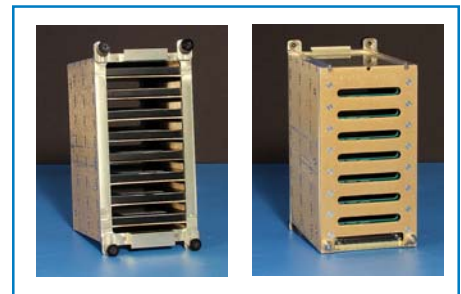

Figure 5. Front and rear view of the QuickPac canister showing the eight SSDs inside.

Floating Inner Chassis

In order to withstand conditions of high vibration and shock, the RTX rackmount chassis is designed to isolate all critical system components by placing them on a floating inner chassis.

This inner chassis is suspended using multiaxis mounts that attenuate externally-transmitted shock and vibration energy. This allows the system to perform flawlessly in aircraft, ships, ground vehicles, UAVs or any other areas of high shock or vibration.

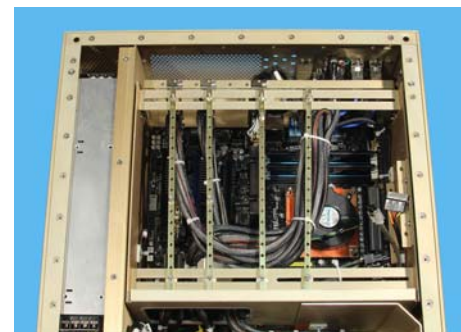

Figure 6. The inner chassis floats with respect to the outer enclosure to improve isolation from shock and vibration.

Cooling and Filtering

Every RTX recorder includes a high-powered forced air-cooling system, to allow the proper transfer of heat from hot system components out the back of the chassis. Cool air is pulled from the front of the system through the QuickPac drive packs and forced over the hottest system components to ensure optimal cooling.

High-powered fans can be controlled via system software to allow the system to

run quietly with lower cooling levels or at maximum air flow levels. This can be adjusted to match the user’s application.

Every RTX recorder includes filtering necessary to protect the system as well as the surrounding operating environment. EMI filters are placed on the front and rear of the chassis, to protect the surrounding environment from radiated emissions. A removable front panel filter protects the system against dust and sand.

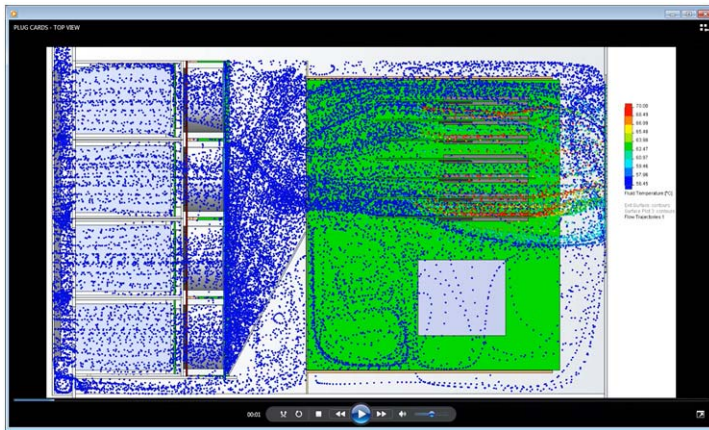

Figure 7. Airflow map shows the extensive ventilation provided to all components inside the RTX rackmount recorder.

Modular Power Supply

Every Talon RTX rackmount Recorder includes a 600 Watt, 85 – 264 V, 47– 400 Hz AC power supply. The power supply has an inline EMI filter to protect against conducted emissions and is isolated from the other electronics in the system, via an isolated chassis compartment. The 400 Hz rating allows every RTX rackmount recorder to operate in aircraft and other environments where smaller, 400 Hz generators are used. For applications that require DC power, 24 V and 28 V DC power supplies are available to replace the AC power supply.

Talon Solutions Chart

The chart below compares Pentek’s different Talon Recording System solutions. As seen here, the RTX Rackmount series

provide high performance and large storage capacity in a rugged package that meets high-level military specifications.

Talon Chassis Type	RTS-COTS Rackmount	RTR Portable	RTR Rackmount	RTX Rackmount	RTX 1/2 ATR
Dimensions (H"xW"xL")	7x19x26	13.4x16.9x9.5	7x19x21/26	7x19x22	8.1x7.1x16.5
Weight (lb)	60–85	30–35	45–85	45–60	30–35
Cooling	Forced-air	Forced-air	Forced-air	Forced-air	Conduction
Storage Drive Type	HDD	SSD	SSD	SSD	SSD
Max. Storage Capacity (TB)	60	7.6	38.4	30.7	3.8
Max. Record Rate (MB/sec)	1600	1600	5000	5000	500
Drive Removal	Individual (with trays)	Individual (no trays)	Individual (with trays)	QuickPac Canisters	Internal (needs disassembly)
Operating Temperature (deg C)	5 to 45	0 to 50	-10 to 55	-20 to 55	-40 to 71
Operating Altitude (ft)	10,000	10,000	10,000	15,000	65,000
Shock	–	15 g	15 g	MIL-STD-810F Method 516.5	MIL-STD-810F Method 516.5
Vibration	–	1.4 g 20–500 Hz	1.4 g 20–500 Hz	MIL-STD-810F Method 514.5	MIL-STD-810F Method 514.5
EMI/EMC	–	–	–	MIL-STD-461E CE101, CE102, CS101 CS114, RE101, RE102 RS101, RS103	MIL-STD-461E CE101, CE102, CS101 RE101, RE102, RS101
ESD	–	–	–	MIL-STD-1686A	–
Sand and Dust	–	–	–	MIL-STD-810F Method 510	MIL-STD-810F Method 510

Appendix A - System Specifications Summary

Parameter	Condition	Specification
Temperature	Operating	-20° C to +55° C
	Non-operating	-40° C to +70° C
Altitude	Operating	0 to 15,000 ft
	Non-operating	0 to 40,000 ft
Humidity	Operating	0-95%, non-condensing
Fungus	Operating	No fungus nutrient material shall be used
Shock	Operating	MIL-STD-810F, Method 516.5, Procedure I (functional shock), 20 g half sine, 12 msec in each axis
Vibration	Operating	MIL-STD-810F, Method 514.5, Procedure I
Airborne Noise	Operating	60 dBA max at 1 meter from the equipment
Structure-borne Noise	Operating	Maximum structure-borne noise per MIL-STD-704-2 is no greater than 60 dB one-third octave L _a , (Type III)
Blowing Dust	Operating	The unit shall resume specified performance after exposed to settling-dust conditions defined in MIL-STD-810F, Method 510, Procedure II - See Note 1
Inclination Angles	Operating	The unit shall maintain specified performance when subjected to: <ul style="list-style-type: none"> ● A static pitch angle of ±5° ● A list angle of 15° ● A roll angle of 45°

Note 1: Standard maintenance includes cleaning of the dust filter(s) as required.

Appendix B - Emissions Specifications Summary

- CE101: Conducted Emissions, Power Leads, 30 Hz to 10 kHz
- CE102: Conducted Emissions, Power Leads, 10 kHz to 10 MHz
- CS101: Conducted Susceptibility, Power Leads, 30 Hz to 50 kHz
- CS114: Conducted Susceptibility, Bulk Cable Injection, 10 kHz to 400 MHz
- CS116: Conducted Susceptibility, Damped Sinusoidal Transients, Cable and Power Leads, 10 kHz to 100 MHz
- RE101: Radiated Emissions, Magnetic Field, 30 Hz to 100 kHz
- RE102: Radiated Emissions, Electric Field, 10 kHz to 18 GHz
- RS101: Radiated Susceptibility, Magnetic Field, 30 Hz to 100 kHz
- RS103: Radiated Susceptibility, Electric Field, 10 kHz to 40 GHz

Specifications are subject to change without notice